

DESIGN FEATURES:

- WORKING PRESSURE : 1000 PSI
- INVESTMENT CASTING BODY & CAP
- TEMPERATURE RATING : -10°C (-50°F) to 230°C (400°F)
- BLOW - OUT - PROOF STEM
- ANTI - STATIC DEVICE
- ADJUSTABLE STEM PACKING
- HANDLE WITH LOCKING DEVICE
- FULL ISO-5211 PAD FOR DIRECT MOUNT AUTOMATION
- End Connections: T-Clamp END
- PTFE CAVITY FILLERS
- FOR FOOD AND GENERAL CHEMICAL SERVICE APPLICATION
- TEST STANDARD: API 598
- ME PTFE SEATS & SEALS AVAILABLE UPON REQUEST
- INTERNAL FINISH 10Ra , OTHER FINISH AVAILABLE ON REQUEST
- Vacuum Service to 29" Hg

SERIES 150 SANITARY BALL VALES



MATERIALS LIST

NO.	PART NAME	MATERIAL	QTY
1	BODY	ASTM A351 Gr.CF8M	1
2	CAP	ASTM A351 Gr.CF8M	2
3	BALL	ASTM A351 Gr.CF8M	1
4	SEAT	PTFE	2
5	BOLT	ASTM A193 Gr.B8	4-6
6	GASKET	PTFE	2
7	THRUST WASHER	PTFE	1
8	STEM	ASTM A276 Gr.316	1
9	O-RING	VITON	1
10	PACKING	PTFE	1
11	RING	SS304	1
12	BELLEVEILLE WASHER	SS410	2
13	HANDLE NUT	SS304	2
14	STOPPER	SS304	1
15	LOCKING PLATE	SS304	1
16	HANDLE	SS304	1
17	HANDLE SLEEVE	VINYL GRIP	1
18	BOLT WASHER	SS304	4-6
19	BOLT NUT	ASTM A194 Gr.8	4-6
20	STOP WASHER	SS304	1

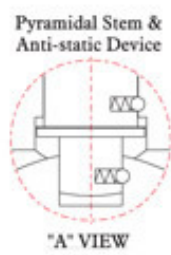
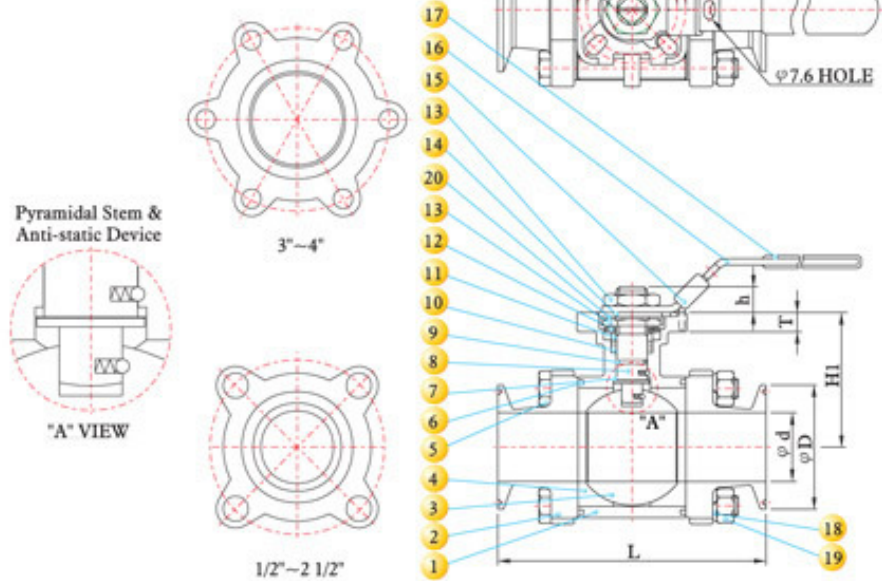

PRESSURE TEMPERATURE RATINGS

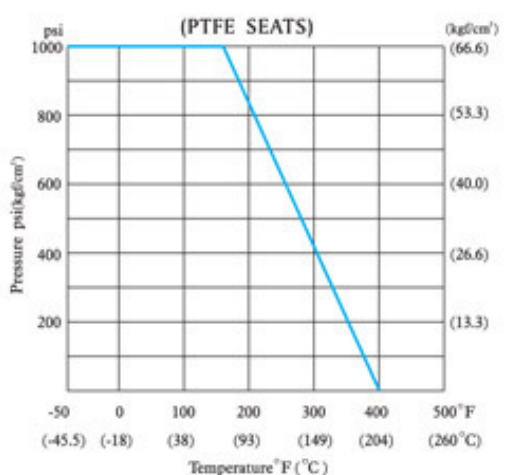

DIMENSIONS

SIZE	d		D		L		H1		h		S		T		ISO 5211	Cv Factor	Weight		
	inch	mm	inch	mm	inch	mm	inch	mm	inch	mm	inch	mm	inch	mm			kg	Lb	
1/2"	15	0.37	9.5	1.00	25.4	3.51	89.2	1.67	42.5	0.31	8.0	0.35	9	0.35	9	F03 / F04	10	0.80	1.76
3/4"	20	0.63	15.9	1.00	25.4	4.00	101.6	1.83	46.5	0.39	10.0	0.35	9	0.35	9	F03 / F04	28	1.05	2.31
1"	25	0.87	22.2	1.98	50.4	4.51	114.6	2.34	59.5	0.45	11.5	0.43	11	0.35	9	F04 / F06	60	1.55	3.41
1 1/2"	40	1.38	35.0	1.98	50.4	5.52	140.2	3.11	79.0	0.78	20.0	0.55	14	0.51	13	F06 / F07	200	3.29	7.25
2"	50	1.87	47.6	2.50	63.6	6.26	159.0	3.42	86.9	0.78	20.0	0.55	14	0.51	13	F06 / F07	450	4.70	10.35
2 1/2"	65	2.37	60.2	3.05	77.5	6.85	174.0	4.41	112.0	1.08	27.5	0.67	17	0.51	13	F07 / F10	700	9.37	20.64
3"	80	2.87	73.0	3.57	90.8	8.00	203.3	4.88	124.0	1.08	27.5	0.67	17	0.51	13	F07 / F10	1000	15.50	34.14
4"	100	3.83	97.4	4.67	118.5	8.90	226.1	6.22	158.0	0.94	24.0	0.67	17	0.79	20	F07 / F10	2000	23.50	51.76